

2. DURING OPERATING THE MACHINE

Use the handle and footstep when getting on or off the machine.

Do not jump on or off the machine.

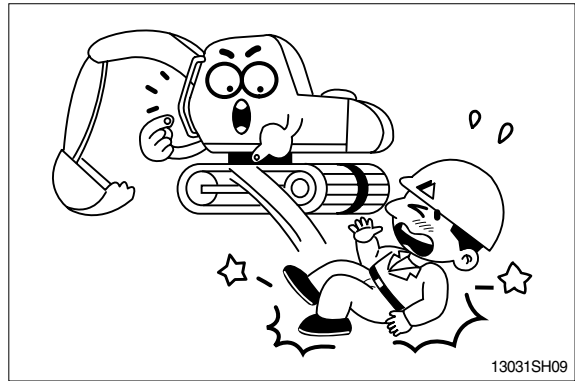

Sound the horn to warn nearby personnel before operating the machine.

Remove all the obstacles like frost on the window before operating the machine for the good visibility.

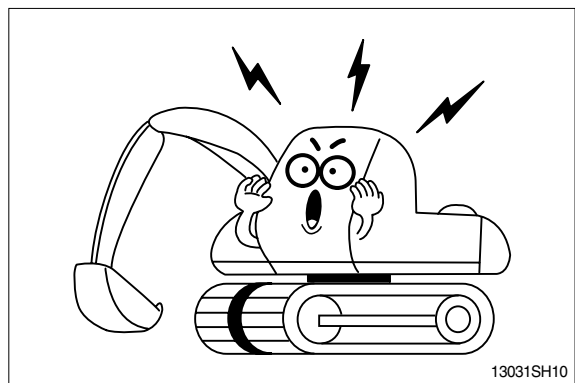

Operate carefully to make sure all personnel or obstacles are clear within the working range of the machine.

Place safety guards if necessary.

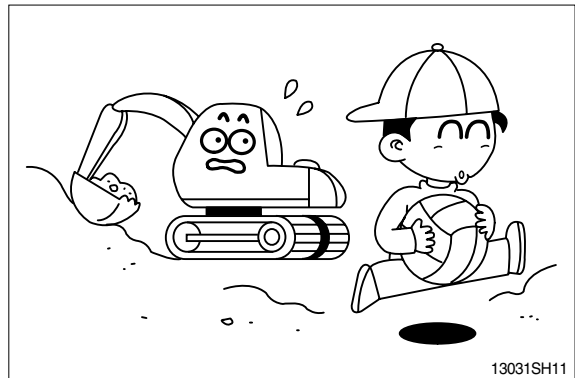

When using the work equipment, pay attention to job site.

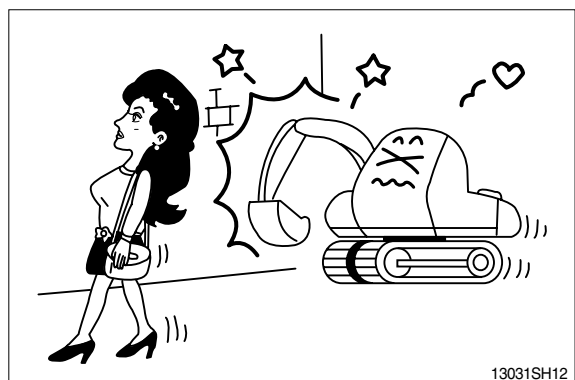

Provide proper ventilation when operating engine in a closed area to avoid the danger of exhaust gases.

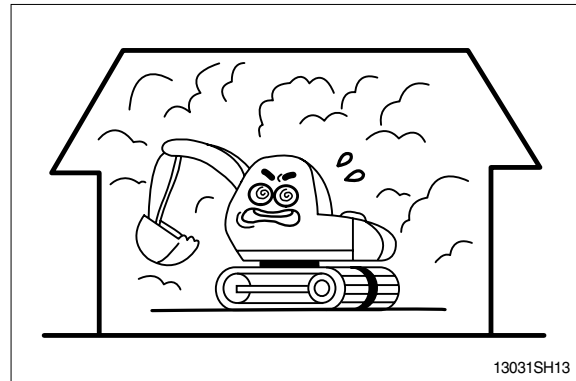

Check the locations of underground gas pipes or water line and secure the safety before operation.

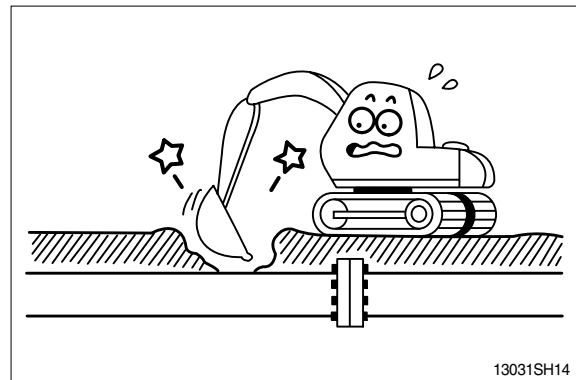

The operating near the electrical lines is very dangerous. Operate within safe working range permitted as below.

Supply voltage	Min safe separation
6.6kV	3m(10ft)
33.0kV	4m(13ft)
66.0kV	5m(16ft)
154.0kV	8m(26ft)
275.0kV	10m(33ft)

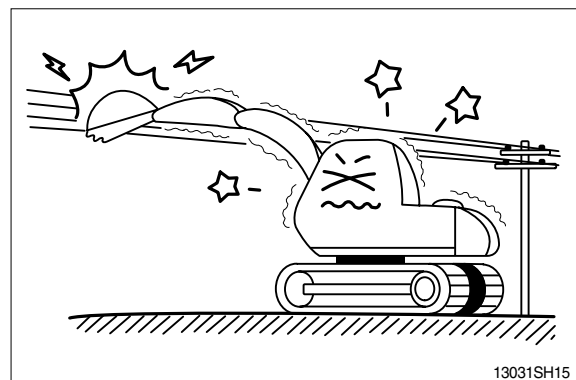

If the machine touches the electric power lines, keep sitting on the operator's seat and make sure the personnel on the ground not to touch the machine until turning off the electric current. Jump off the machine do not contact the machine when you need to get off.

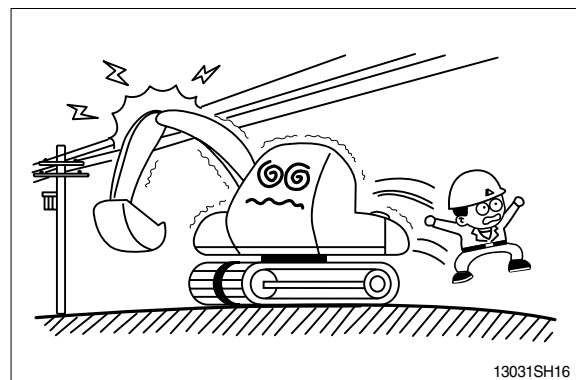

Watch out for obstacles.
Be particularly careful to check the machine clearance during the swing.

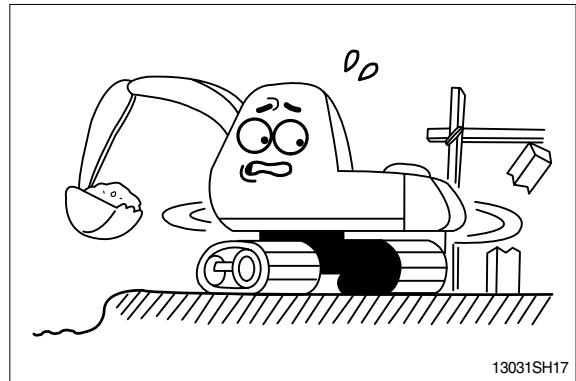

When using the machine as breaker or working in a place where stones may fall down, cab roof guard and head guard should be provided for proper protection.

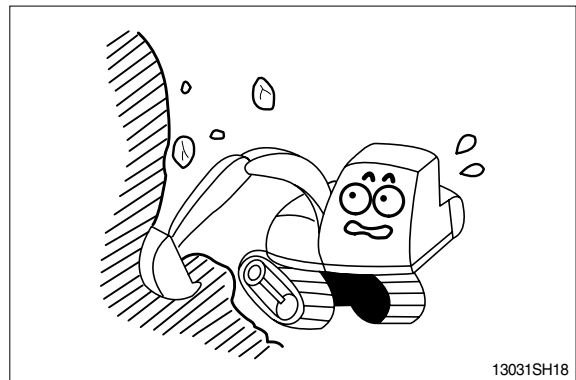

Avoid operating on a cliff or soft ground as there is danger of rolling over.
Make to get off easily as keeping the track at a right angle and putting the travel motor into the backward position when working on a cliff or soft ground inevitably.

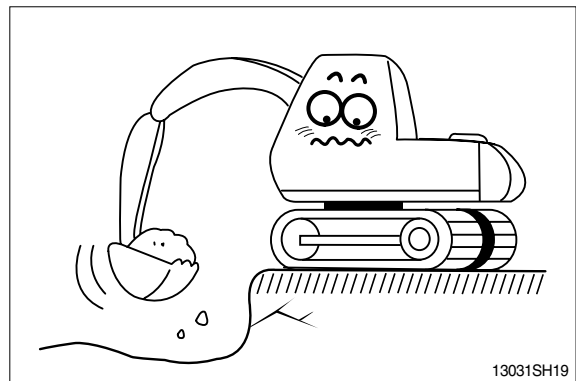

Operate for the lifting work considering the capacity of machine, weight and width of the load.
Be careful not to lift exceeding the machine capacity as it can be the cause of machine damage and safety accident.

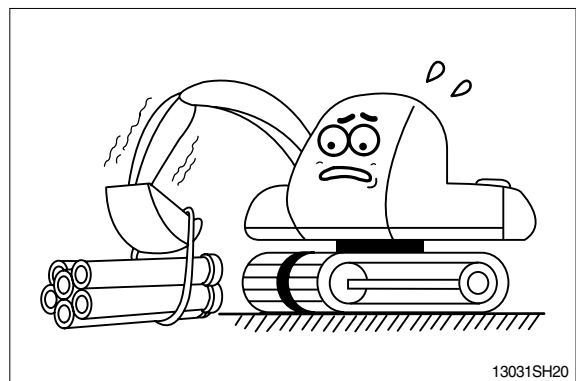

The operation on a slope is dangerous.
Avoid operating the machine on a slope of over 10 degree.

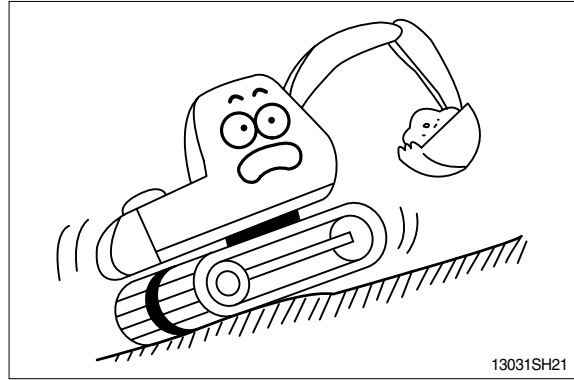

Operate the machine after making ground flat when operation is required on a slope.

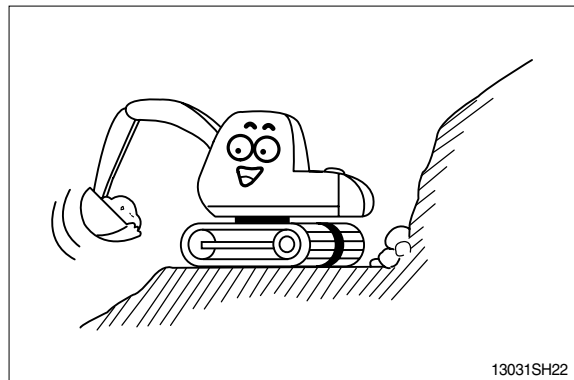

The swing on the slope can be danger of rolling over.
Do not operate to swing the machine with the bucket loaded on a slope since the machine may lose its balance under such an instance.

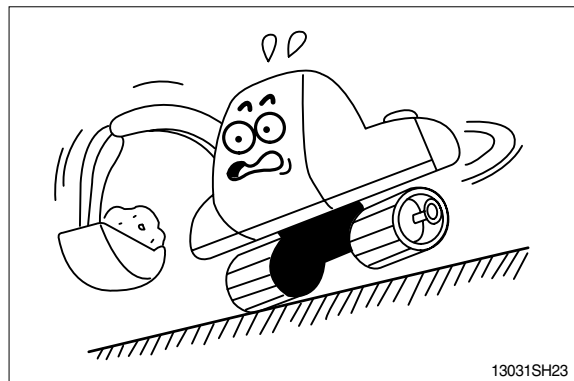

Avoid parking and stopping on a slope.
Lower the bucket to the ground and block the track when parking.

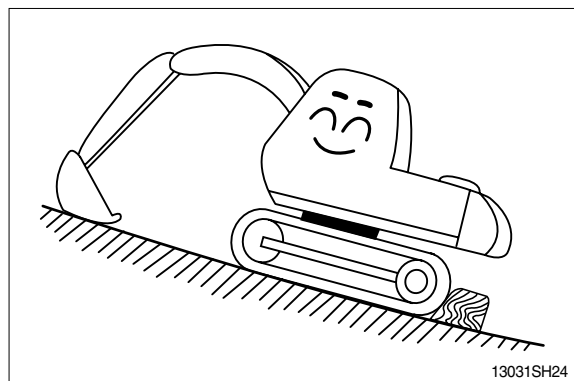

Avoid traveling in a cross direction on a slope as it can cause the danger of rolling over and sliding.

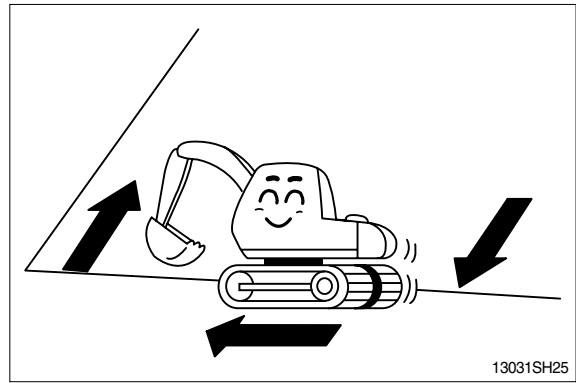

Traveling on a slope is dangerous. Be sure to operate slowly when traveling down a slope and maintain the bucket at a height of 20~30cm(1ft) above the ground so that it can be used as brake in an emergency.

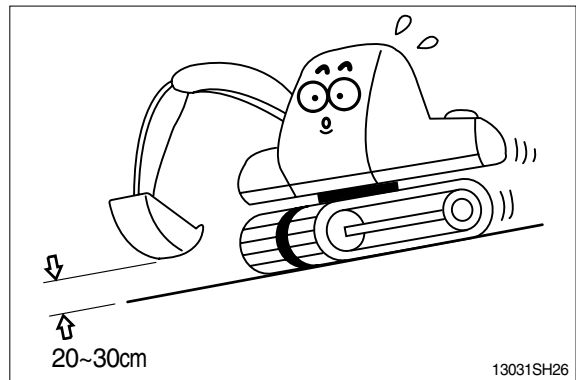

Steering of the machine while traveling on a slope is dangerous. When an inevitable turning of direction is required, turn on the flat and solid ground.

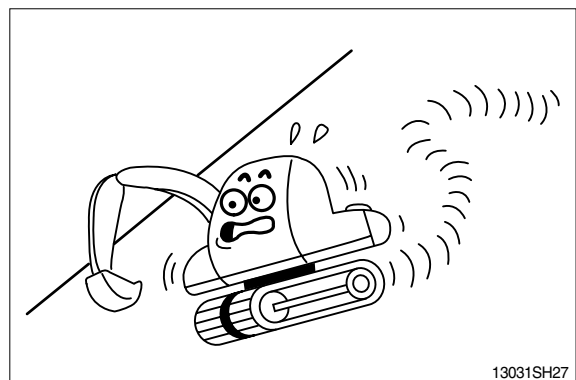

The engine angularity limits are 35 degree. Do not operate by more than the engine limits in any case.

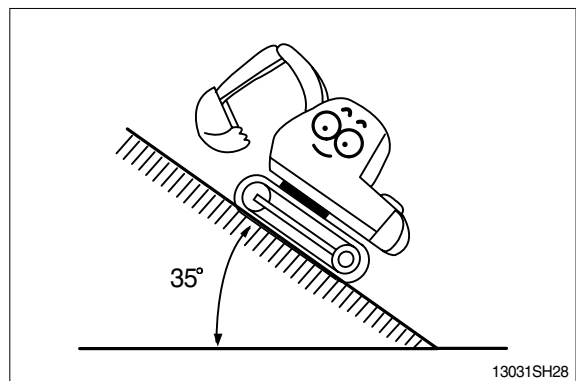

Before traveling the machine, sound the horn to warn nearby personnel.
Operate forward and backward correctly with confirming the location of the travel motor.

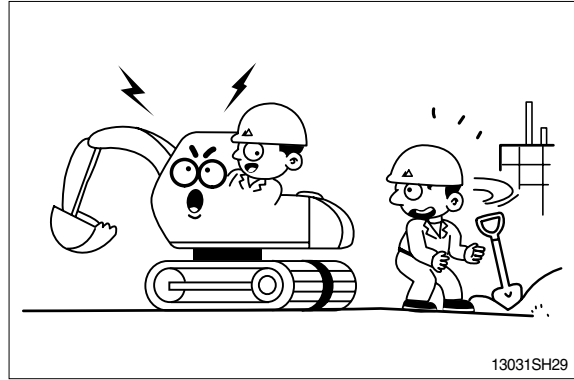

Slow down when traveling through obstacles or uneven ground.

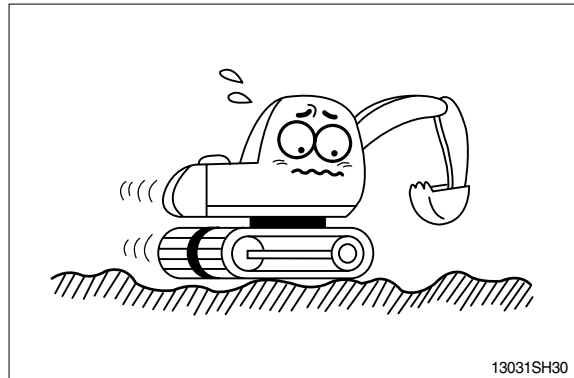

When working on soft ground, place mats or wood boards on the ground to prevent the machine sinking.

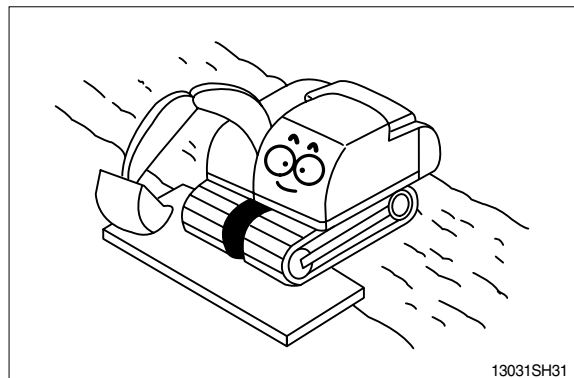

When operating in water or when crossing shallow, check the bed soil condition and depth and flow speed of water, then proceed taking care that water is not above carrier roller.

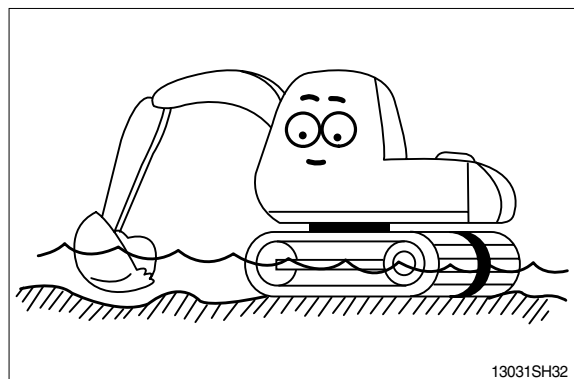

Do not retract the track gauge except transporting purpose.

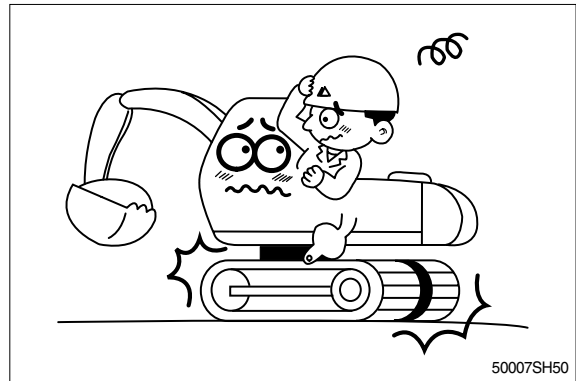

MOUNTING AND DISMOUNTING

Never jump on or off the machine. **Never** get on or off a moving machine.

When mounting or dismounting, always face the machine and use the handrails, machine or track frame steps, and track shoes. Additional track frame step can be fitted for wider optional shoe. In this case please contact your Hyundai distributor.

Do not hold any control levers when getting on or off the machine.

Ensure safety by always maintaining at least three-point contact of hands and feet with the handrails, steps or track shoes.

Always remove any oil or mud from the handrails, steps and track shoes. If they are damaged, repair them and tighten any loose bolts.

If grasping the door handrail when mounting or dismounting or moving on the track, open and lock the door securely in the open position. Otherwise, the door may move suddenly, causing you to lose balance and fall.

