

3. WORKING RANGE

1) 2.5m(8' 2") MONO BOOM WITH BOOM SWING POST

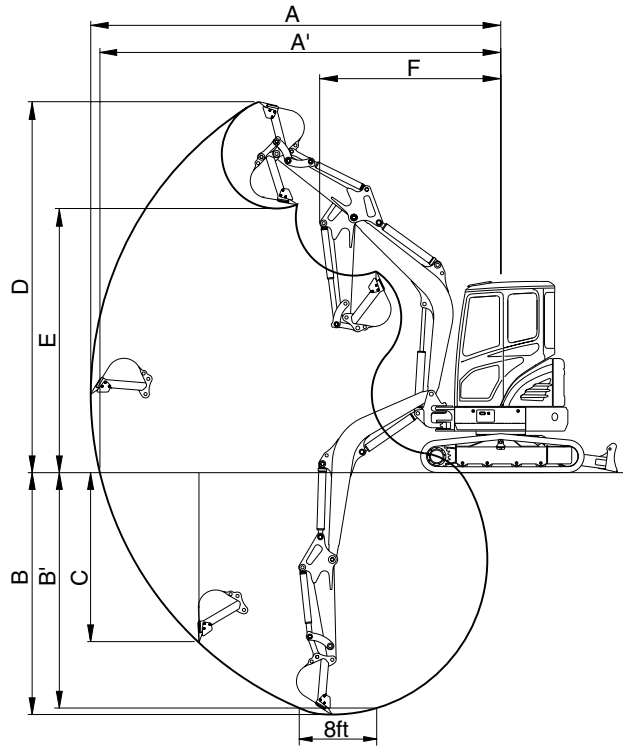

R5572SP03

Description		1.3m(4' 3") Arm
Max digging reach	A	5360mm (17' 7")
Max digging reach on ground	A'	5240mm (17' 2")
Max digging depth	B	3150mm (10' 4")
Max digging depth (8ft level)	B'	2660mm (8' 9")
Max vertical wall digging depth	C	2190mm (7' 2")
Max digging height	D	4830mm (15'10")
Max dumping height	E	3460mm (11' 4")
Min swing radius	F	2350mm (7' 9")
Boom swing radius(left/right)		75° /50°
Bucket digging force	SAE	27.9 kN
		2850 kgf
		6280 lbf
	ISO	31.4 kN
		3200 kgf
		7050 lbf
Arm crowd force	SAE	18.9 kN
		1930 kgf
		4250 lbf
	ISO	19.5 kN
		1990 kgf
		4390 lbf